



Series SM20, SM40, SM50, SM60 & SM80

Super Marathon Series Gas Fryers Installation & Operation Manual



Dean, a member of the Commercial Food Equipment Service Association, recommends using CFESA Certified Technicians.

PRINTED IN THE USA

www.frymaster.com

24-Hour Service Hotline 1-800-551-8633

E-mail: service@frymaster.com

OCTOBER 2011

* 8196001A *

Please read all sections of this manual and retain for future reference.

NOTICE

This appliance is intended for professional use only and is to be operated by qualified personnel only. A Frymaster Dean Factory Authorized Servicer (FAS) or other qualified professional should perform installation, maintenance, and repairs. Installation, maintenance, or repairs by unqualified personnel may void the manufacturer's warranty. See Chapter 1 of this manual for definitions of qualified personnel.

NOTICE

This equipment must be installed in accordance with the appropriate national and local codes of the country and/or region in which the appliance is installed. See NATIONAL CODE REQUIREMENTS in Chapter 3 of this manual for specifics.

NOTICE

This equipment is to be installed in compliance with the basic plumbing code of the Building Officials and Code Administrators International, Inc. (BOCA) and the Food Service Sanitation Manual of the U.S. Food and Drug Administration.

NOTICE

Drawings and photos used in this manual are intended to illustrate operational, cleaning and technical procedures and may not conform to onsite management operational procedures.

NOTICE

IF, DURING THE WARRANTY PERIOD, THE CUSTOMER USES A PART FOR THIS MANITOWOC FOOD SERVICE EQUIPMENT OTHER THAN AN UNMODIFIED NEW OR RECYCLED PART PURCHASED DIRECTLY FROM FRYMASTER DEAN, OR ANY OF ITS AUTHORIZED SERVICERS, AND/OR THE PART BEING USED IS MODIFIED FROM ITS ORIGINAL CONFIGURATION, THIS WARRANTY WILL BE VOID. FURTHER, FRYMASTER DEAN AND ITS AFFILIATES WILL NOT BE LIABLE FOR ANY CLAIMS, DAMAGES OR EXPENSES INCURRED BY THE CUSTOMER WHICH ARISE DIRECTLY OR INDIRECTLY, IN WHOLE OR IN PART, DUE TO THE INSTALLATION OF ANY MODIFIED PART AND/OR PART RECEIVED FROM AN UNAUTHORIZED SERVICER.

 DANGER

Improper installation, adjustment, maintenance or service, and unauthorized alterations or modifications can cause property damage, injury, or death. Read the installation, operating and service instructions thoroughly before installing or servicing this equipment. Only qualified service personnel may convert this appliance to use a gas other than that for which it was originally configured.

 DANGER

Adequate means must be provided to limit the movement of this appliance without depending upon the gas line connection. Single fryers equipped with legs must be stabilized by installing anchor straps. All fryers equipped with casters must be stabilized by installing restraining chains. If a flexible gas line is used, an additional restraining cable must be connected at all times when the fryer is in use.

⚠ DANGER

The front ledge of the fryer is not a step. Do not stand on the fryer. Serious injury can result from slips or contact with the hot oil.

⚠ DANGER

Do not store or use gasoline or other flammable vapors and liquids in the vicinity of this or any other cooking appliance.

⚠ DANGER

Instructions explaining procedures to be followed **MUST** be posted in a prominent location in the event the operator detects a gas leak. This information can be obtained from the local gas company or gas supplier.

⚠ DANGER

The crumb tray in fryers equipped with a filter system must be emptied into a fireproof container at the end of frying operations each day. Some food particles can spontaneously combust if left soaking in certain shortening material. Additional information can be obtained in the filtration manual included with the system.

⚠ WARNING

No structural material on the fryer should be altered or removed to accommodate placement of the fryer under a hood. Questions? Call the Frymaster Dean Service Hotline at 1-800-551-8633.

⚠ WARNING

Do not bang fry baskets or other utensils on the fryer's joiner strip. The strip is present to seal the joint between the frypot. Banging fry baskets on the strip to dislodge shortening will distort the strip, adversely affecting its fit. It is designed for a tight fit and should only be removed for cleaning.

IMPORTANT

Safe and satisfactory operation of Frymaster Dean equipment depends upon its proper installation. Installation **MUST** conform with local codes, or in the absence of local codes, to European Union (CE) Standards.

NOTICE

The Commonwealth of Massachusetts requires any and all gas products to be installed by a licensed plumber or pipe fitter.



**Super Marathon Series Gas Fryers
Installation & Operation Manual**

TABLE OF CONTENTS

	Page #
1. INTRODUCTION	1-1
1.1 Applicability and Validity	1-1
1.2 Ordering Parts	1-1
1.3 Service Information	1-1
1.4 Safety Information	1-2
1.5 Definitions	1-2
2. IMPORTANT INFORMATION	2-1
2.1 Receiving and Unpacking Equipment	2-1
2.2 General	2-1
2.3 Principles of Operation	2-2
2.4 Rating Plate	2-2
2.5 Pre-Installation	2-3
2.6 Equipment Installed at High Altitudes	2-4
2.7 Air Supply and Ventilation	2-5
2.8 Conversion of Units	2-5
3. INSTALLATION INSTRUCTIONS	3-1
3.1 Installing the Fryer	3-1
3.2 Leg and Caster Installation	3-1
3.3 Leveling the Fryer	3-2
3.4 Gas Connections	3-4
3.5 Adjustments/Adaptation to Different Gases	3-9
3.6 Gas Inputs	3-10
3.7 Gas Conversion Procedures	3-12
3.8 Gas Conversion Components	3-15
3.9 Electrical Connections	3-15



**Super Marathon Series Gas Fryers
Installation & Operation Manual**

TABLE OF CONTENTS (CONT.)

	Page #
4. FRYER OPERATIONS	4-1
4.1 Initial Start-up	4-1
4.2 Boil-Out Procedure	4-3
4.3 Final Preparation	4-5
5. PREVENTATIVE MAINTENANCE	5-1
5.1 General	5-1
6. TROUBLESHOOTING	6-1
6.1 General	6-1
6.2 Pilot Burner Malfunction	6-1
6.3 Main Burner Malfunctions	6-2
6.4 Wiring Diagrams	6-3
6.5 Recommended Spare Parts	6-4

SUPER MARATHON SERIES GAS FRYERS

CHAPTER 1: INTRODUCTION

1.1 Applicability and Validity

Dean Super Marathon Series gas model family has been approved by the European Union (EU) for sale and installation in all EU countries.

This manual is applicable to and valid for all Dean Super Marathon Series gas units sold in English-speaking countries, including those in the European Union. Where conflicts exist between instructions and information in this manual and local or national codes of the country in which the equipment is installed, installation and operation shall comply with those codes.

This appliance is for professional use only. Operating information for Dean equipment has been prepared for use by qualified and/or authorized personnel only, as defined in Section 1.5. All installation and service on Dean equipment must be performed by qualified, certified, licensed, and/or authorized installation or service personnel, as defined in Section 1.5.

1.2 Ordering Parts

Customers may order parts directly from their local Authorized Parts Distributor. For this address and phone number, contact your maintenance and repair center or call the factory. The factory address and phone numbers are on the back cover of this manual.

To speed up your order, the following information is required:

Model Number	_____	Type	_____
Serial Number	_____		_____
Optional Equipment	_____		
Item Part Number	_____	Quantity Needed	_____

1.3 Service Information

Call the 1-800-551-8633 or (318) 865-1711 Service Hotline number for the location of your nearest maintenance and repair center. Always give the model and serial numbers of your fryer.

To assist you more efficiently, the following information will be needed:

Model Number	_____	Type	_____
Serial Number	_____		
Optional Equipment	_____		
Nature of Problem	_____ _____		

Additional information (i.e. cooking environment, time of day, and other pertinent information) may be helpful in solving your service problem.

SUPER MARATHON SERIES GAS FRYERS

CHAPTER 1: INTRODUCTION

1.4 Safety Information

Before attempting to operate your unit, read the instructions in this manual thoroughly.

Throughout this manual, you will find notations enclosed in double-bordered boxes similar to the ones below.

CAUTION

CAUTION boxes contain information about actions or conditions that *may cause or result in a malfunction of your system.*

WARNING

WARNING boxes contain information about actions or conditions that *may cause or result in damage to your system, and which may cause your system to malfunction.*

DANGER

DANGER boxes contain information about actions or conditions that *may cause or result in injury to personnel, and which may cause damage to your system and/or cause your system to malfunction.*

1.5 Definitions

Qualified and/or Authorized Operating Personnel

Qualified/authorized operating personnel are those who have carefully read the information in this manual and have familiarized themselves with the equipment functions, or have had previous experience with the operation of equipment covered in this manual.

Qualified Installation Personnel

Qualified installation personnel are individuals, or firms, corporations, or companies, which, either in person or through a representative are engaged in and are responsible for the installation of gas-fired appliances. Qualified personnel must be experienced in such work, be familiar with all gas precautions involved, and have complied with all requirements of applicable national and local codes.

Qualified Service Personnel

Qualified service personnel are those who are familiar with Dean equipment and have been authorized by Dean to perform service on Dean equipment. All authorized service personnel are required to be equipped with a complete set of service parts manuals and stock a minimum amount of parts for Dean equipment. A list of Frymaster Dean Factory Authorized Servicers (FAS's) is located on the Frymaster website at www.frymaster.com. *Failure to use qualified service personnel will void the Dean warranty on your equipment.*

SUPER MARATHON SERIES GAS FRYERS

CHAPTER 2: IMPORTANT INFORMATION

2.1 Receiving and Unpacking Equipment

- A. Check that the container is upright. Use an outward prying motion - *no hammering* - to remove the carton. Unpack the fryer carefully and remove all accessories from the carton. Do not discard or misplace these, as they will be needed.
- B. After unpacking, immediately check the equipment for visible signs of shipping damage. If damage has occurred, contact the carrier and file the appropriate freight claims. Do not contact the factory. Shipping damage responsibility is between the carrier and the dealer.

If your equipment arrives damaged:

1. File claim for damages immediately, regardless of extent of damage.
2. Visible loss or damage: Be sure this is noted on the freight bill or express receipt and is signed by the person making the delivery.
3. Concealed loss or damage: If damage is unnoticed until equipment is unpacked, notify freight company or carrier immediately, and file a concealed damage claim. This should be done within 15 days of date of delivery. Be sure to retain container and all packing materials for inspection.

NOTE: Dean Does Not Assume Responsibility for Damage or Loss Incurred in Transit.

- C. Remove all plastic skin from sides, front, and doors of the fryer(s). Failure to do this prior to initial fryer operation will make it very difficult to remove later.

2.2 General

Qualified, licensed, and/or authorized installation or service personnel only (as defined in Section 1.5) should perform the following:

- **Installation and service on Dean equipment.**
- **Conversion of this appliance from one gas type to another.**

Failure to use qualified, licensed, and/or authorized installation or service personnel to install, convert to another gas type or otherwise service this equipment will void the Dean warranty and may result in damage to the equipment or injury to personnel.

Where conflicts exist between instructions and information in this manual and local code or national codes, or regulations, installation and operation shall comply with the codes or regulations in force in the country in which the equipment is installed.

SUPER MARATHON SERIES GAS FRYERS CHAPTER 2: IMPORTANT INFORMATION

2.2 General (cont.)

Dean Super Marathon Series gas fryers are energy efficient gas-fired units. All units are shipped completely assembled, with accessories packed inside the frypot. All units are adjusted, tested, and inspected at the factory prior to crating for shipment.

WARNING

The on-site supervisor is responsible for ensuring that operators are made aware of the inherent dangers of operating a hot-oil fryer/filter system, particularly the aspects of fryer operation, oil filtration, and draining/cleaning procedures.

2.3 Principles of Operation

The incoming gas flows through orifices and is mixed with air in the burners to create the correct ratio for proper combustion. The mixture is ignited at the front end of each heat tube by the pilot light. Internal diffusers slow the flame as it goes through the burner tube. This slower and more turbulent flame gives much better heat transfer to the walls of the tubes, thereby heating the oil more efficiently.

2.4 Rating Plate

DANGER

Fryers MUST be connected ONLY to the gas type identified on the attached rating plate.

The rating plate can be found on the inside panel of the fryer door. Information on this plate includes the model and serial numbers, kW/hr (BTU/hr) of the burners, outlet gas pressure in mbars (inches W.C.), and configuration: natural or propane gas. Rating plate data is essential for proper unit identification, communicating with the factory or requesting special parts and/or information.

**SUPER MARATHON SERIES GAS FRYERS
CHAPTER 2: IMPORTANT INFORMATION**

2.5 Pre-Installation

 **DANGER**

No structural material on the fryer should be altered or removed to accommodate placement of the fryer under a hood. Questions? Call the Frymaster Dean Service Hotline at 1-800-551-8633.

 **DANGER**

Do not connect this appliance to the gas supply before reviewing all information in this chapter.

- A. **General:** Only licensed personnel should install any gas-fired equipment.
1. A manual gas shut-off valve must be installed in the gas supply line ahead of the fryers for safety and ease of future service.
 2. Dean Super Marathon Series gas fryers operate on millivolts, and do not require an external electric power supply (unless equipped with a built-in filtration system).
- B. **Clearances:** The fryer area must be kept free and clear of all combustibles. This unit is design-certified for the following installations:
1. Commercial installation only (not for household use).
 2. Non-combustible floor installation equipped with factory-supplied 6-inch (15-cm) adjustable legs or 5-inch (13-cm) casters;
 3. Combustible construction with a minimum clearance of 6-inches (15-cm) side and 6-inches (15-cm) rear, and equipped with factory-supplied 6-inch (15-cm) adjustable legs or 5-inch (13-cm) casters.

 **DANGER**

Local building codes prohibit a fryer with its open tank of hot oil from being installed beside an open flame of any type, including those of broilers and ranges.

**SUPER MARATHON SERIES GAS FRYERS
CHAPTER 2: IMPORTANT INFORMATION**

2.5 Pre-Installation (cont.)

C. Installation Standards

1. CE/EXPORT STANDARDS: Fryer installation must conform with local codes, or in the absence of local codes, to the appropriate national or European Community (CE) standards.
2. NON-CE INSTALLATION STANDARDS: Fryer installation must conform with local codes, or in the absence of local codes, to the appropriate national standards as listed below:

<p>a. <u>U.S. installations must meet:</u></p> <p>American National Standard Institute ANSI Z83.11 American Gas Association 8501 E. Pleasant Valley Road Cleveland, OH 44131</p> <p>National Electrical Code ANSI/NFPA #70 American National Standard Institute 1430 Broadway New York, NY 10018</p> <p>NFPA Standards #96 and #211 National Fire Protection Association 470 Atlantic Avenue Boston, MA 02110</p>	<p>b. <u>Canadian installations must meet:</u></p> <p>CAN 1-B149 Installation Codes Canadian Gas Association 55 Scarsdale Road Don Mills, ONT, M3B 2R3</p> <p>Canadian Electric Code c22.1, part 1 Canadian Standards Association 178 Rexdale Blvd. Rexdale, ONT, M9W 1R3</p>
---	---

2.6 Equipment Installed at High Altitudes

1. The fryer input rating [BTU/hr (kW/hr)] is for elevations up to 2,000 feet (610-m). For elevations above 2,000 feet (610-m), the rating should be reduced 4-percent for each additional 1,000 feet (305-m) above sea level.
2. The correct orifices are installed at the factory if the operating altitude is known at the time of the customer's order.

SUPER MARATHON SERIES GAS FRYERS CHAPTER 2: IMPORTANT INFORMATION

2.7 Air Supply and Ventilation

 **DANGER**

This appliance must be installed with sufficient ventilation to prevent the occurrence of unacceptable concentrations of substances harmful to the health of personnel in the room in which it is installed.

Keep the area around the fryer clear to prevent obstruction of combustion and ventilation airflow.

1. Do not connect this fryer to an exhaust duct.
2. Correct installation and adjustment will ensure adequate airflow to the fryer system.
3. A commercial, heavy-duty fryer must vent its combustion wastes to the outside of the building. A deep-fat fryer must be installed under a powered exhaust hood, or an exhaust fan must be provided in the wall above the unit, as exhaust gas temperatures are approximately 800-1000°F (427-538°C). Check air movement during installation. Strong exhaust fans in the exhaust hood or in the overall air conditioning system can produce slight air drafts in the room.
4. Do not place the fryer's flue outlet directly into the plenum of the hood, as it will affect the gas combustion of the fryer.
5. Never use the interior of the fryer cabinet for storage or store items on shelving over or behind the fryer. Exhaust temperatures can exceed 800°F (427°C) and may damage or melt items stored in or near the fryer.
6. Adequate distance must be maintained from the flue outlet of the fryer(s) to the lower edge of the filter bank. Per NFPA Standards No. 96, a minimum of 18-inches (45-cm) should be maintained between the flue(s) and the lower edge of the exhaust hood filter.
7. Filters and drip troughs should be part of any industrial hood, but consult local codes before constructing and installing any hood. The duct system, the exhaust hood and the filter bank must be cleaned on a regular basis and kept free of grease.

2.8 Conversion of Units

Pressure:

1 mbar = 10,2 mm W.C. = 0,4-inch W.C.

20 mbar = 204 mm W.C. = 8-inch W.C.

1-inch W.C. = 25,4 mm W.C. = 2,5 mbar

Heat Input:

1 kW = 3410 BTU/hr

100 BTU/hr = 0,0293 kW

Temperature:

0° Celsius = 32° Fahrenheit

Temperature in degrees Celsius = (Temperature in degrees Fahrenheit (F) – 32) x 0,555

100° Celsius = (212° Fahrenheit – 32) x 0,555

SUPER MARATHON SERIES GAS FRYERS

CHAPTER 3: INSTALLATION INSTRUCTIONS

3.1 Installing the Fryer

- A. **Initial Installation:** If installed with legs, do not push against the fryer's side to adjust its position. Use a pallet or lift jack to lift the fryer slightly and place it where it is to be installed.
- B. **Relocating the Fryer:** If relocating a fryer installed with legs, remove all weight from each leg before moving.

Note: If a leg becomes damaged during movement, contact your service agent for immediate repair/replacement.

 **CAUTION**

Fryers must be at room temperature, empty of oil, and if fitted with legs, lifted during movement to avoid damage and possible bodily injury.

 **DANGER**

Hot oil can cause severe burns. Avoid contact. Under all circumstances, oil must be removed from the fryer before attempting to move it to avoid oil spills, and the falls and severe burns that could occur. This fryer may tip and cause personal injury if not secured in a stationary position.

3.2 Leg and Caster Installation

 **WARNING**

Dean fryers equipped with legs are for permanent installations. Fryers fitted with legs must be lifted during movement to avoid damage and possible bodily injury. For a moveable or portable installation, Dean optional equipment casters must be used. Questions? Call 1-800-551-8633.

 **CAUTION**

Fryers may not function properly if curb mounted. **Do not** curb mount Super Marathon gas fryers.

A. General

1. Install legs and rear rigid casters near where the fryer is to be used, as neither is secure for long transit. Unit cannot be curb mounted and must be equipped with the legs and casters provided.
2. When positioning the fryer, gently lower the fryer into position to prevent undue strain to the legs and internal mounting hardware. Use a pallet or lift jack to lift and position the fryer if possible. Tilting the fryer may damage the legs.

SUPER MARATHON SERIES GAS FRYERS CHAPTER 3: INSTALLATION INSTRUCTIONS

3.2 Leg and Caster Installation (cont.)

3. Rigid casters must be installed on the fryer rear-channel assembly only.
4. Proceed to Step 3.3, Leveling the Fryer, after legs and rear rigid casters are installed to ensure the fryer is level before using.

B. Leg and Rigid Caster Installation

1. Remove unit from pallet.
2. Carefully raise unit with forklift, pallet jack, or other steady means.
3. Place one lock washer on each hex head screw.
4. Insert hex head screws with lock washers [1/4-20 threads by 3/4" (19 mm) long] through bolt holes of leg mounting plates and mount to the front channel. Mount rigid casters to the rear channel following the same procedure. A locknut has been attached to the topside of the base mounting plates at the factory to capture the hex head screw as it is screwed in.
5. Tighten the bolts to 50 inch-lbs. (5.65 Nm) torque.

3.3 Leveling the Fryer

- A. Place a carpenter's level across the top of the fryer and level the unit front to back. If the fryer is not level from side to side, a platform or other surface adjustment is needed; there is no side-to-side level adjustment on a fryer equipped with caster/leg combinations. (If a fryer is equipped with legs only, side-to-side level adjustments can be made. If a fryer is equipped with casters only, no level adjustments can be made.) If the fryer is not level, the unit may not function efficiently, the oil may not drain properly for filtering and in a multi-fryer battery, it may not match adjacent units.

Legs (Only)

1. Adjust leg height with an adjustable or 1-1/16-inch (27 mm) open-end wrench by turning the hex bullet on the bottom of the leg.
2. The hex bullet is for minor leg height adjustment only. **Do not adjust more than 1-inch (25.4 mm).**
3. When leveling the unit, the leg body should be held firmly to keep the leg from bending or rotating while turning the hex bullet foot to the required height.

SUPER MARATHON SERIES GAS FRYERS

CHAPTER 3: INSTALLATION INSTRUCTIONS

3.3 Leveling the Fryer (cont.)

Rigid Casters (Only)

1. Install the rigid casters on the fryer rear channel only. Legs must be installed on the front channel.
 2. There are no level adjustments for the rigid casters.
- B. If the floor is uneven or has a decided slope, place the fryer on a smooth, level platform.
- C. If the fryer is moved, re-level the fryer following the instructions given in Steps 3.3, A-C.
- D. An installed fryer must be restrained to prevent tipping, which could splash hot oil. Restraints can be straps or chains anchored to an immovable object (wall, floor anchor), or the manner of installation (installing the fryer in an alcove, battering to other appliances, etc.).



WARNING

For caster retrofit, the unit must be at room temperature and drained of shortening before installing the casters.

E. Installing Optional Swivel Casters:

1. Install non-locking casters only at the rear of the unit.
2. Locking casters must be installed at the front of the unit. Locking casters allow the fryer to be "locked" in position for safe operations.
3. Follow the same instructions for leg installations as given above in steps 3.2, B 1-5.

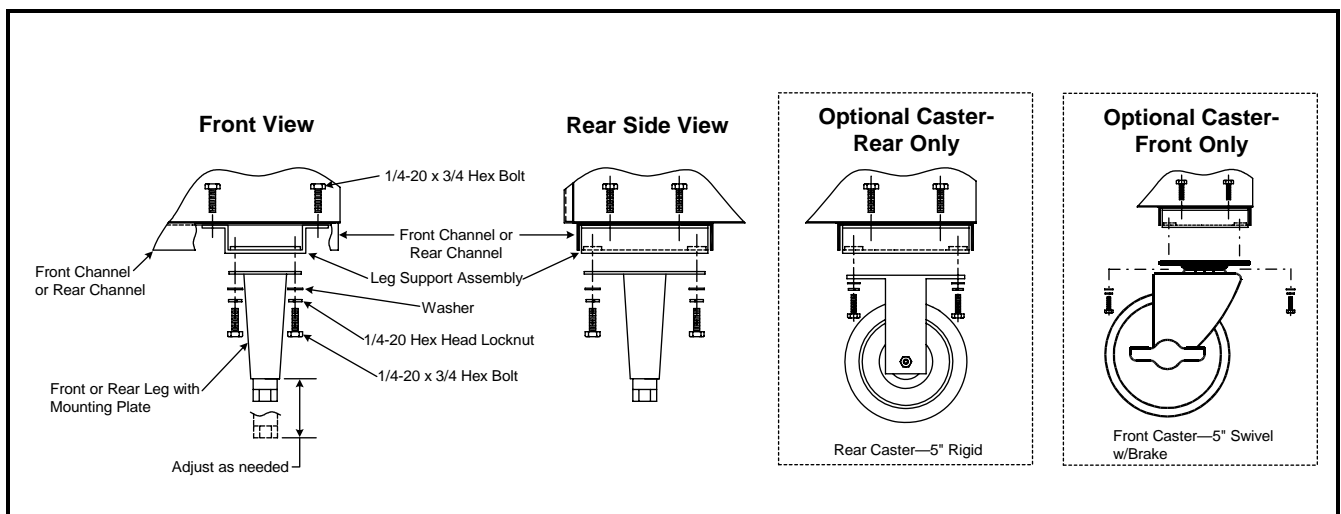

Leg and Caster (Optional) Mounting Installation

SUPER MARATHON SERIES GAS FRYERS CHAPTER 3: INSTALLATION INSTRUCTIONS

3.3 Leveling the Fryer (cont.)

NOTE: The installation must be inspected after it is complete to ensure it meets the intent of these instructions. The on-site supervisor and/or operator(s) should be informed that the appliance is installed with restraints. If restraints are removed to move fryer (cleaning beneath and behind, relocation, etc.), ensure that they are re-installed when fryer is returned to its permanently installed position.

 **DANGER**

The fryer MUST be connected to the gas supply specified on the rating and serial number plate located on the back of the fryer door.

 **WARNING**

If gas odors are detected, the gas supply MUST be shut off at the main shut-off valve. The local gas company or FAS should be contacted immediately to rectify the problem.

3.4 Gas Connections

CE REQUIREMENTS

Super Marathon Series gas fryers have obtained CE markings for countries and gas categories shown below:

COUNTRIES	CATEGORIES	GAS	PRESSURE (MBAR)
GERMANY (DE)	I12ELL3B/P	G20/G25; G30/G31	20 50
	I3P	G31	50
AUSTRIA (AT)	I12H3B/P	G20; G30/G31	20 50
BELGIUM (BE)	I2E(R)B	G20/G25	20/25
	I3+	G30/G31	28-30/37
DENMARK (DK) FINLAND (FI) SWEDEN (SE)	I12H3B/P	G20; G30/G31	20 30
SPAIN (ES) GREECE (GR) ITALY (IT) IRELAND (IE) PORTUGAL (PT) UNITED KINGDOM (GB)	I12H3+	G20; G30/G31	20 28-30/37
SPAIN (ES)	I12H3P	G20; G31	20 37 AND 50
FRANCE (FR)	I12Esi3+	G20/G25; G30/G31	20/25 28-30/37
	I12Esi3P	G20/G25; G31	20/25 50
LUXEMBOURG (LU)	I12E3B/P	G20; G30/G31	20 50
NETHERLANDS (NL)	I12L3P	G25; G31	25 50
	I12L3B/P	G25; G30/G31	25 30

SUPER MARATHON SERIES GAS FRYERS CHAPTER 3: INSTALLATION INSTRUCTIONS

3.4 Gas Connections (cont.)

NATIONAL CODE REQUIREMENTS: NON-CE

This equipment is to be installed in compliance with the Basic Plumbing Code of the Building Officials and Code Administrators International, Inc. (BOCA) and the Food Service Sanitation Manual of the U.S. Food and Drug Administration.

This equipment is manufactured to use the type of gas specified on the rating plate attached to the door. Connect equipment stamped "NAT" only to natural gas and that stamped "PRO" only to LP (Propane) gas.

Australia Only: Installation is to be in accordance with the requirements of AS5601/AG601, local regulatory authority requirements and other statutory regulations.

 **WARNING**

If the incoming gas pressure is in excess of ½" PSI (3.45 kPa/35 mbar), a step-down regulator will be required.

 **DANGER**

Before connecting new pipe to this appliance, the pipe must be blown out thoroughly to remove all foreign material. Foreign material in the burner and gas controls will cause improper and dangerous operation.

NOTICE

Installation shall be made with a gas connector that complies with national and local codes. Quick disconnect devices, if used, shall likewise comply with national and local codes.

 **DANGER**

The fryer **MUST** be connected to the gas supply specified on the rating and serial number plate located on the back of the fryer door.

The gas supply (service) line must be the same size or greater than the fryer inlet line. Super Marathon Series gas fryers are equipped with a 3/4" (22 mm) male ISO 7.1 inlet. The gas supply line must be sized to accommodate all gas-fired equipment connected to that gas supply. Consult local gas companies or suppliers, or your local contractor for minimum supply line requirements.

SUPER MARATHON SERIES GAS FRYERS

CHAPTER 3: INSTALLATION INSTRUCTIONS

3.4 Gas Connections (cont.)

Supply Line Specifications

The incoming gas supply line should be a minimum of 1½" (40 mm) in diameter.

The gas supply lines must be sized as indicated in the chart below, based on the total number of fryers connected to the main gas supply.

Recommended Gas Connection Line Sizes			
Gas Types	Number of Fryers		
	1	2 to 3	4 or 5 (*)
Natural Gas	¾" (20 mm)	1" (25 mm)	1-¼" (32 mm)
Propane Gas	½" (15 mm)	¾" (20 mm)	1" (25 mm)

(*) When exceeding 18 feet (6 meters) for a configuration of four to five fryers, it is necessary to provide a 1-¼" (32 mm) rigid gas connection. For six or more fryers, contact factory for connection line specifications.

 **DANGER**

All connections must be sealed with a joint compound suitable for the gas being used and all connections must be tested with a solution of soapy water before lighting any pilots.

Never use matches, candles, or any other ignition source to check for leaks. If gas odors are detected, shut off the gas supply to the appliance at the main shut-off valve and immediately contact the local gas company or an authorized service agency for service.

 **DANGER**

"Dry-firing" your unit will cause damage to the frypot and can cause a fire. Always ensure that melted shortening, cooking oil or water is in the frypot before firing the unit.

Rigid Connections

Check any installer-supplied intake pipe(s) visually and clean metal particles or other foreign matter from the threads before installing into a service line. If the intake pipes are not clear of all foreign matter, the orifices will clog when gas pressure is applied. When using thread compound on gas piping, use very small amounts and only on male threads. Use a pipe thread compound that is not affected by the chemical action of LP gases. **DO NOT** apply thread compound to the first two pipe threads – doing so will cause clogging of the burner orifices and control valve.

Manual Shut-Off Valve

This gas service supplier-installed valve must be installed in the gas service line ahead of the fryers in the gas stream and in a position where it can be reached quickly in the event of an emergency.

SUPER MARATHON SERIES GAS FRYERS CHAPTER 3: INSTALLATION INSTRUCTIONS

3.4 Gas Connections (cont.)

Regulating Gas Pressure

The fryer and shut-off valve must be disconnected from the gas supply during any pressure testing of the system.

External gas regulators are not normally required on this fryer. A safety control valve protects the fryer against pressure fluctuations. If the incoming pressure is in excess of ½" PSI (3.45 kPa/35 mbar), **a step-down regulator will be required.**

 **DANGER**

When pressure-testing incoming gas supply lines, disconnect the fryer from the gas line if the test pressure is ½" PSI [3,45 kPa/35 mbar (14 inches W.C.)] or greater to avoid damage to the fryer's gas piping and gas valve(s).

- A. Manifold Pressure: A service technician should check the manifold pressure with a manometer.
1. Check the rating plate for manifold gas pressures. Natural gas units normally require 4-inches W.C. (10 mbars), and propane units normally require 11-inches W.C. (27 mbars) gas pressure.
 2. Confirm that the arrow forged into the bottom of the regulator body, which indicates gas flow direction, is pointed downstream towards the fryers. The air vent cap is also part of the regulator and should not be removed.
 3. If a vent line from the gas pressure regulator is used, it should be installed in accordance with local codes or in the absence of local codes, with the appropriate national or European Community (CE) standards.

 **WARNING**

Use a diluted soap solution to find potentially dangerous gas leaks when making new connections.

- B. Regulators: Gas regulators can be adjusted in the field, but no adjustments should be made unless the regulator is out of adjustment, or serious pressure fluctuations are observed.
- C. Only qualified service personnel should make adjustments to the regulators.
- D. Orifices: The fryer can be configured to operate on any available gas. The correct safety control valve, appropriate gas orifices, and pilot burner are installed at the factory. While the valve can be adjusted in the field, only qualified service personnel should make any adjustments with the proper test equipment.

SUPER MARATHON SERIES GAS FRYERS

CHAPTER 3: INSTALLATION INSTRUCTIONS

3.4 Gas Connections (cont.)

1. CE ONLY: The following color codes indicate the type of gas to be used for each fryer and associated components.

Gas Type	CE Color Code
Natural	Blue
Propane	Red

E. Flexible Couplings, Connectors and Casters

1. If the fryer is to be installed with flexible couplings and/or quick-disconnect fittings, the installer must use a heavy-duty certified commercial flexible connector of at least 3/4" (22 mm) NPT (with suitable strain-relief attachments), in compliance with local codes or in the absence of local codes, with the appropriate national or European Community (CE) standards. Quick-disconnect devices must comply with local codes or in the absence of local codes, with the appropriate national or European Community (CE) standards.
2. For an appliance equipped with casters, the installation shall be made with a connector that complies with local codes or in the absence of local codes, with the appropriate national or European Community (CE) standards.
3. Under no circumstances are the connector and the quick-disconnect device, or its associated piping to be used to limit fryer movement. A restraining bracket is provided on the appliance back to prevent the unit from moving from its installed position.

 **WARNING**

Do not attach accessories to this fryer unless fryer is secured from tipping. Personal injury may result.

4. To limit movement of the fryer, restraints independent of the flexible coupling or connector must be used. Clips are located on the back panel of the fryer for the attachment of restraints.
5. If disconnection of the restraint is necessary, the restraint must be reconnected after the fryer has been returned to the position it was originally installed.

- F. After hook up, bleed the gas line of air to ensure that the pilot light will ignite quickly and evenly.

 **WARNING**

Qualified personnel MUST perform any adaptation, modification, or gas conversion, if required. Failure to use qualified personnel will void the Dean warranty.

**SUPER MARATHON SERIES GAS FRYERS
CHAPTER 3: INSTALLATION INSTRUCTIONS**

3.5 Adjustments/Adaptation To Different Gases

- A. Proper operation of appliances requires operator to inspect the following adjustments in Section 3.6 in terms of gas inputs and pressures.
- B. Dean Super Marathon Series gas fryers are manufactured to use the type of gas and pressure specified on the rating plate. When changing gas, **adaptation must be performed by qualified personnel**. Failure to use qualified personnel will void the Dean warranty.

 **DANGER**

This appliance was configured at the factory for a specific type of gas. Converting from one gas type to another requires the installation of specific gas-conversion components.

Switching to a different type of gas without installing the proper conversion components may result in fire or explosion. NEVER ATTACH THIS APPLIANCE TO A GAS SUPPLY FOR WHICH IT IS NOT CONFIGURED!

Conversion of this appliance from one type of gas to another should only be performed by qualified, licensed, and authorized installation or service personnel, as defined in Section 1.5 of this manual.

SUPER MARATHON SERIES GAS FRYERS CHAPTER 3: INSTALLATION INSTRUCTIONS

3.6 Gas Inputs

CE UNITS ONLY:

A. Nominal Heat Inputs (Qn), Gas Type, Orifice Size, Part Number and Quantity/Color are listed in the table below:

MODEL	NOMINAL HEAT INPUT- Qn (kW)	GAS TYPE	ORIFICE SIZE (MM)	ORIFICE PART NO.	ORIFICE QTY/ COLOR
SM 80 GM	37.5	G20	2.40	810-2060	5/BBLUE
		G25	2.40	810-2060	5/BBLUE
		G31	1.51	810-2059	5/RED
SM 60 GM	37.5	G20	2.40	810-2060	5/BBLUE
		G25	2.40	810-2060	5/BBLUE
		G31	1.51	810-2059	5/RED
SM 50 GM	30	G20	2.40	810-2060	4/BBLUE
		G25	2.40	810-2060	4/BBLUE
		G31	1.51	810-2059	4/RED
SM 35 GM SM 40 GM	26	G20	2.40	810-2060	3/BBLUE
		G25	2.40	810-2060	3/BBLUE
		G31	1.51	810-2059	3/RED
SM 20 GM	15	G20	2.40	810-2060	2/BBLUE
		G25	2.40	810-2060	2/BBLUE
		G31	1.51	810-2059	2/RED

B. Adjustments for different gases are as follows:

MODEL*	ORIFICE SIZE (MM)	GAS TYPE	MANIFOLD GAS PRESSURE**		BURNER MARKING	PILOT MARKING
			MBAR	INCH W.C.		
SM 80 GM	2,40	G20	10,0	4,0	Blue	26N
	2,40	G25	15,0	6,0	Blue	26N
	1,51	G31	27,0	10,8	Red	16LP
	2,40(1)	G25(1)	10,0(1)	4,0(1)	Blue	26N
SM 60 GM	2,40	G20	12,0	4,8	Blue	26N
	2,40	G25	17,5	7,0	Blue	26N
	1,51	G31	22,0	8,8	Red	16LP
SM 50 GM	2,40	G20	12,0	4,8	Blue	26N
	2,40	G25	17,5	7,0	Blue	26N
	1,51	G31	22,0	8,8	Red	16LP
SM 35 GM SM 40 GM	2,40	G20	12,0	4,8	Blue	26N
	2,40	G25	17,5	7,0	Blue	26N
	1,51	G31	22,0	8,8	Red	16LP
SM 20 GM	2,40	G20	12,0	4,8	Blue	26N
	2,40	G25	17,5	7,0	Blue	26N
	1,51	G31	22,0	8,8	Red	16LP

*SM prefix- Super Marathon Series
 *GM suffix- gas millivolt system with no electrical supply connections required
 (1) The Netherlands (NL) only.

NOTE: Outlet gas pressure must be adjusted strictly within the above requirements 5 to 10 minutes after the appliance is operating.

** For controls and adjustments, please refer to the gas valve illustration on page 3-13. (Pilot Flame Adjustment: Turn the pilot adjustment screw clockwise/counter-clockwise until the desired flame-volume is achieved).

**SUPER MARATHON SERIES GAS FRYERS
CHAPTER 3: INSTALLATION INSTRUCTIONS**

3.6 Gas Inputs (cont.)

NON-CE ONLY:

A. Nominal Heat Inputs (Qn), Gas Type, Orifice Size (applicable for fryer operation at altitudes of 2000 feet or less), Part Number and Quantity are listed in the table below:

MODEL	NOMINAL HEAT INPUT- Qn (BTU)	GAS TYPE	ORIFICE SIZE (MM)	ORIFICE PART NO.	ORIFICE QUANTITY
SM 80 GM	165	NAT	2.58(#38)	810-2062	5
		LP	1.61(#52)	810-2063	5
SM 60 GM	150	NAT	2.53(#39)	810-2048	5
		LP	1.51(#53)	810-2059	5
SM 50 GM	120	NAT	2.53(#39)	810-2048	4
		LP	1.51(#53)	810-2059	4
SM 35 GM	105	NAT	2.80(#35)	810-2040	3
SM 40 GM		LP	1.70(#51)	810-2064	3
SM 20 GM	50	NAT	2.18(#44)	810-2050	2
		LP	1.40(#54)	810-0710	2

B. Adjustments for different gases are as follows:

Gas Adjustments		
Gas Type	Natural	LP
Incoming Gas Supply Pressure*	6"-14" W.C. (15-35 mbars)	12"-14" W.C. (30-35 mbars)
Orifice Diameter	See Table Above.	See Table Above.
Burner Marking	None	None
Pilot Marking	26N	16LP
Manifold Gas Pressure [Inches W.C. (mbar)]*	4" W.C. (10 mbars)	11" W.C. (27.5 mbars)

NOTE: Outlet gas pressure must be adjusted strictly within the above requirements 5 to 10 minutes after the appliance is operating.

* For controls and adjustments, please refer to gas valve illustration on page 3-14. (Pilot Flame Adjustment: Turn the pilot adjustment screw clockwise/counter-clockwise until the desired flame-volume is achieved).

SUPER MARATHON SERIES GAS FRYERS CHAPTER 3: INSTALLATION INSTRUCTIONS

3.7 Gas Conversion Procedures

 **DANGER**

This appliance was configured at the factory for a specific type of gas. Converting from one gas type to another requires the installation of specific gas-conversion components.

Switching to a different type of gas without installing the proper conversion components may result in fire or explosion. NEVER ATTACH THIS APPLIANCE TO A GAS SUPPLY FOR WHICH IT IS NOT CONFIGURED!

Conversion of this appliance from one type of gas to another should only be performed by qualified, licensed, and authorized installation or service personnel, as defined in Section 1.5 of this manual.

CE UNITS ONLY:

See page 3-13 for gas valve illustration and gas valve, burner and orifice location when performing the following conversions.

When converting from G20 to G25 gas, the following procedures apply:

- ◆ Equipment replacement is not required.
- ◆ Adjust orifice gas pressure to the appropriate value listed in the table on page 3-10 by turning the gas valve "adjustment screw".
- ◆ After adjustment, replace the adjustment-screw cover.

When converting from G20 (or G25) gas to G31 propane (or vice-versa), the following procedures apply:

- ◆ Burner orifices and pilot orifice **MUST** be replaced.
- ◆ Adjust orifice gas pressure to the appropriate value listed in the table on page 3-10 by turning the gas-valve adjustment screw.
- ◆ After adjustment, replace the adjustment-screw cover.
- ◆ Affix the new rating plate included with the conversion kit. If a new rating plate was not included contact your local FASC to obtain one.

When converting from G20 (20 mbar) to G25 (25 mbar), or vice-versa, the following procedures apply:

- ◆ Check pilot-adjustment and adjust as necessary.
- ◆ Other adjustments are not necessary.

SUPER MARATHON SERIES GAS FRYERS

CHAPTER 3: INSTALLATION INSTRUCTIONS

3.7 Gas Conversion Procedures (cont.)

Conversion from one gas family to another (i.e. changing from natural gas to propane) requires special components. Obtain the necessary components using the cross-reference in Section 3.8, Gas Conversion Components.

Conversions can only be executed by qualified, factory-authorized personnel.

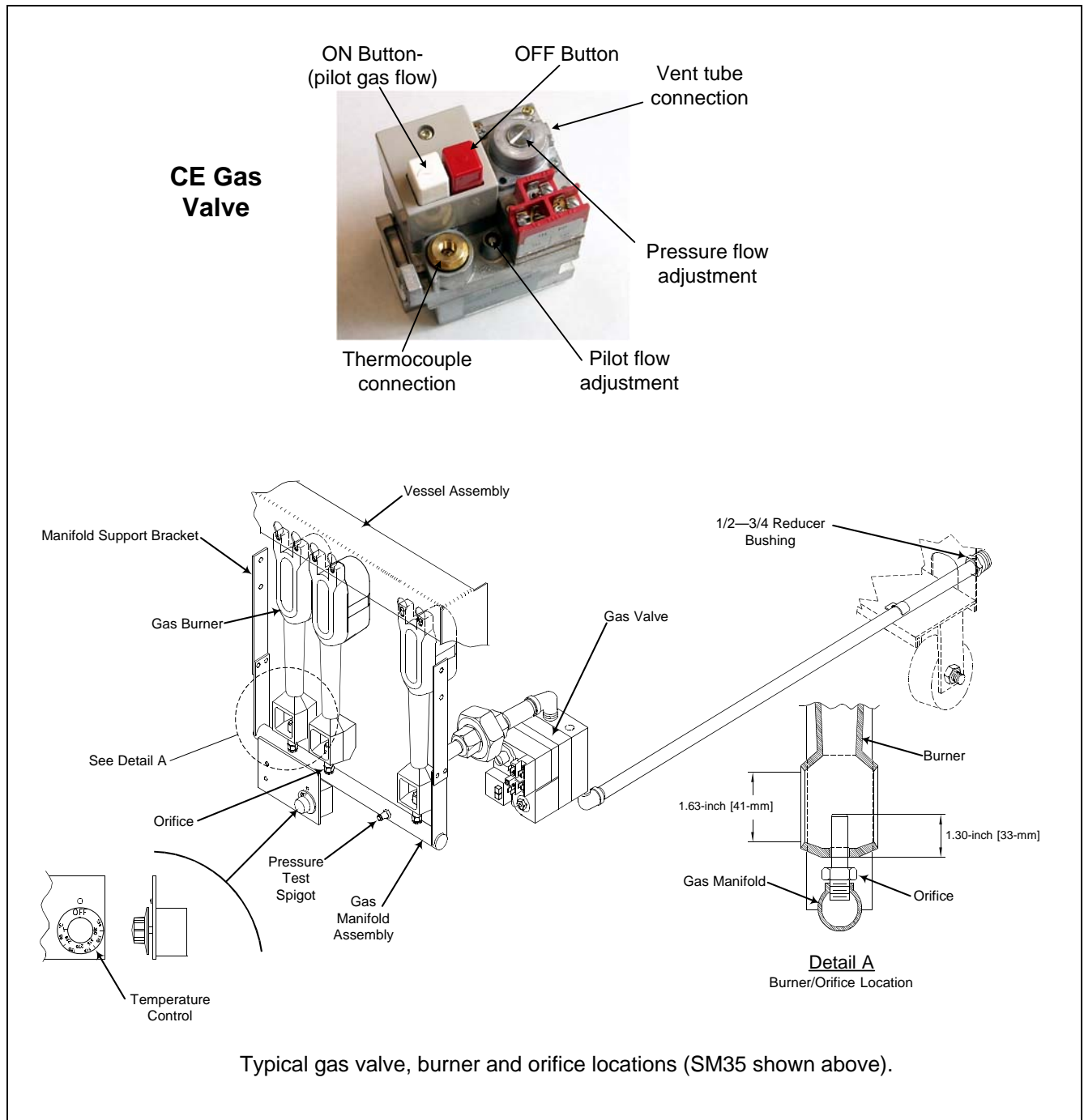

SUPER MARATHON SERIES GAS FRYERS CHAPTER 3: INSTALLATION INSTRUCTIONS

3.7 Gas Conversion Procedures (cont.)

NON-CE UNITS ONLY:

See gas valve illustration below and gas valve, burner and orifice location on page 3-15 when performing the following conversions.

When converting from natural gas to propane (or vice-versa), the following procedures apply:

- ◆ Burner orifices and pilot orifice **MUST** be replaced (see page 3-11 for required component part numbers).
- ◆ Adjust orifice gas pressure by turning the gas-valve adjustment screw (see page 3-11 for gas types and pressures).
- ◆ After adjustment, replace the adjustment-screw cover.
- ◆ Affix the new label included with the conversion kit next to the existing rating plate stating that the gas type has been converted. Remove any references to the previously used gas from the existing rating plate.

Conversion from one gas family to another (i.e. changing from natural gas to propane) requires special components. Obtain the necessary components using the tables on page 3-11.

Conversions can only be executed by qualified, factory-authorized personnel.

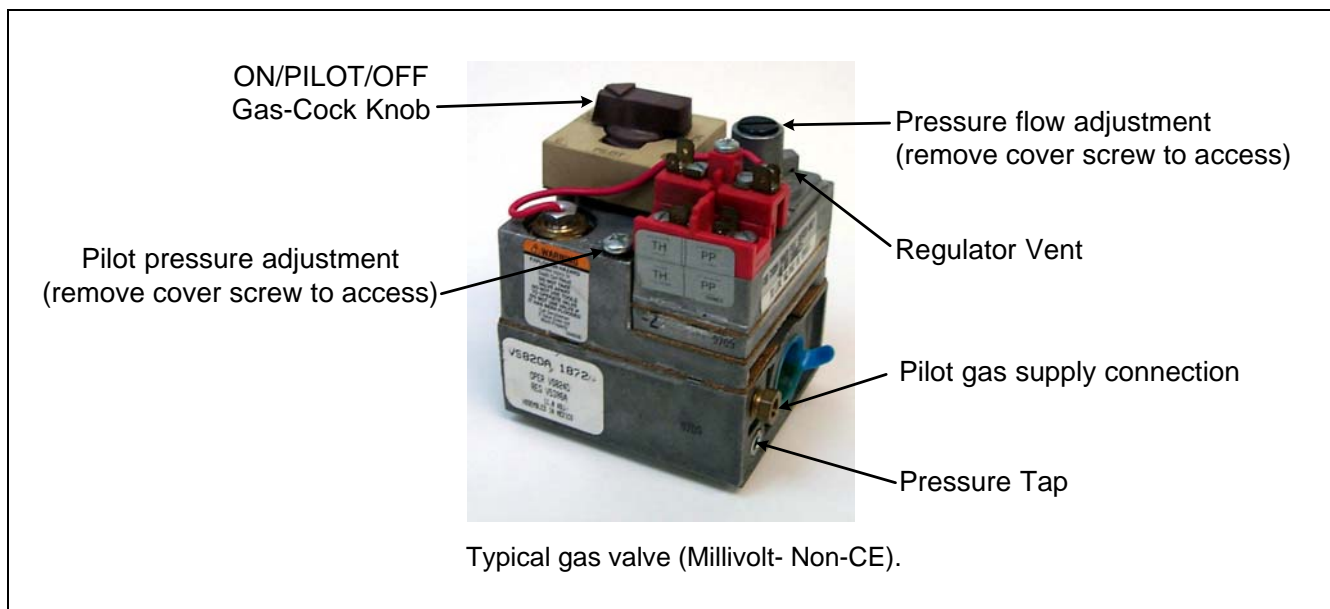

**SUPER MARATHON SERIES GAS FRYERS
CHAPTER 3: INSTALLATION INSTRUCTIONS**

3.8 Gas Conversion Components

Use the following components to convert from natural gas to propane and vice-versa. See Section 3.6 for orifice quantities required for conversion.

Natural Gas to Propane Components		Propane To Natural Gas Components	
REF	DESCRIPTION	REF	DESCRIPTION
810-2400	Pilot orifice (16LP)	810-0811	Pilot orifice (26N)
Burner orifice* (See Tables on Page 3-10 – 3-11)		Burner orifice* (See Table on Page 3-10 – 3-11)	
New Rating Label	Contact factory at time of conversion. PN 802-2144	New Rating Label	Contact factory at time of conversion. PN 802-2144
* Burner orifices listed on page 3-10 – 3-11 are for fryers operating at altitudes of 2000 feet (610 meters) or less. For altitudes greater than 2000 feet (610 meters), contact the factory for the correct orifice size.			

3.9 Electrical Connections

Fryers without built-in filtration do not require electrical connection. Fryer systems with built-in filtration when installed must be electrically grounded in accordance with local codes, or in the absence of local codes, with the appropriate national standards.

 WARNING

Fryers with built-in filtration systems are equipped with a three-prong (grounding) plug for protection against shock hazard. It should be plugged directly into a properly grounded, three-prong receptacle. DO NOT CUT, REMOVE, OR OTHERWISE BYPASS THE GROUNDING PRONG ON THIS PLUG.

For fryers with built-in filtration systems: The rating plate and wiring diagram are located on the inside front door panel. Built-in filtration systems are equipped with 120VAC single-phase 60-hertz system (Domestic), or 230VAC single-phase 50-hertz system (International/CE). Do not cut or remove the ground prong from the power cord plug.

 DANGER

This appliance requires electrical power (built-in filtration systems only) for operation. Place the gas control valve in the OFF position in case of a prolonged power outage. Do not attempt to operate this appliance during a power outage.

SUPER MARATHON SERIES GAS FRYERS

CHAPTER 4: FRYER OPERATIONS

4.1 Initial Start-up

⚠ WARNING

The on-site supervisor is responsible for ensuring that operators are made aware of the inherent hazards of operating a hot oil frying system, particularly the aspects of system operation, oil filtration, draining and cleaning procedures.

Cleaning: New units are wiped clean with solvents at the factory to remove any visible signs of dirt, oil, grease, etc. remaining from the manufacturing process, then coated lightly with oil. Before any food preparation, wash thoroughly with hot, soapy water to remove any film residue and dust or debris then rinse out and wipe dry. Also wash any accessories shipped with the unit. Close the drain valve completely and remove the crumb screen covering the heating tubes. Ensure the screws holding the thermostat and high-limit control sensing bulbs into the frypot are tight.



Typical frypot drain valve (SM40 shown).

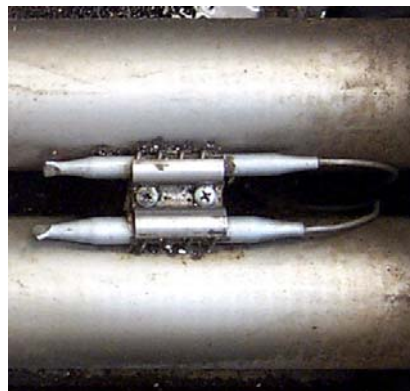

Typical high-limit/sensor probe location and mounting hardware.

⚠ WARNING

Do not bang fry baskets or other utensils on the fryer's joiner strip. The strip is present to seal the joint between the frypots. Banging fry baskets on the strip to dislodge shortening will distort the strip, adversely affecting its fit. It is designed for a tight fit and should only be removed for cleaning.

⚠ DANGER

Never operate this appliance with an empty frypot. The frypot must be filled with water, oil or shortening before lighting the burners. Failure to do so will damage the frypot and may cause a fire.

⚠ WARNING

When checking for burner ignition or performance, do not get too close to the burners. Slow ignition can cause possible flashback, increasing the potential for facial and body burns.

SUPER MARATHON SERIES GAS FRYERS

CHAPTER 4: FRYER OPERATIONS

4.1.1 Pilot Lighting Procedures, Standing Pilot Only

Initial Pilot Lighting: All Dean fryers are tested, adjusted and calibrated to sea level conditions before leaving the factory. Adjustments to assure proper operation of pilot may be necessary on installation to meet local conditions, low gas pressure, differences in altitude and variations in gas characteristics. These adjustments correct possible problems caused by rough handling or vibration during shipment, and are to be performed only by qualified service personnel. These adjustments are the responsibility of the customer and/or the dealer and are not covered by the Dean warranty.

The inlet pipe at the lower rear of the fryer brings incoming gas to the pilot safety control valve, then to the pilot and main burners. The pilot is located high in the cabinet center, at the base of the frypot.



Honeywell CE Gas Valve

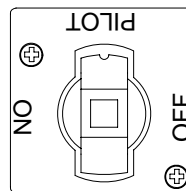

PILOT Position

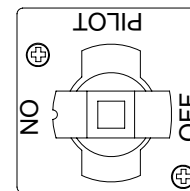

ON Position

Non-CE Gas Valve

Perform the following steps in sequence before lighting or re-lighting the pilot:

1. Turn the operating thermostat "OFF".
2. **For CE units:** Depress the Pilot Off button (red) on the safety control valve to turn "OFF".
For Non-CE units: Depress and turn the gas valve knob to the OFF position.
3. Wait at least 5 minutes for any accumulated gas to disperse.

NOTE: Inspect high-limit thermostat/temperature probe locations prior to filling frypot with water or oil. Ensure that connecting hardware is intact and bulbs are properly attached.

4. Fill the frypot with oil or water to the bottom OIL LEVEL line scribed on the frypot back. Ensure heating tubes are covered in liquid prior to engaging burners.
5. Open the manual shut-off valve on the incoming service line. **For Non-CE units:** Rotate the gas valve knob to the pilot position.

If fryer is equipped with a piezo ignitor, go to Step 7.

SUPER MARATHON SERIES GAS FRYERS

CHAPTER 4: FRYER OPERATIONS

4.1.1 Pilot Lighting Procedures, Standing Pilot Only (cont.)

6. **For CE units:** Apply a lighted match or taper to the pilot burner head. Press the white pilot light button on the gas valve and hold approximately 45 seconds to 1 minute, until the pilot stays lit.
For Non-CE units: Push and hold the knob in and apply a lighted match or taper to the pilot burner head. Continue to hold the knob in for about 60 seconds after the flame appears on the pilot. Release the knob. The pilot should remain lit.
7. If fryer is equipped with a piezo ignitor, press and hold the white pilot light button, then repeatedly press the piezo ignitor button until the pilot lights. Release the white button after approximately 45 seconds to 1 minute.
8. If the pilot does not stay lit, depress the white pilot light button and re-light the pilot, holding the button in longer before releasing. Trapped air may necessitate re-lighting the pilot several times until a constant gas flow is attained.
9. When the pilot stays lit, release the white pilot light button.

4.2 Boil-Out Procedure

 **DANGER**

Never leave the fryer unattended during the boil-out process. If the boil-out solution boils over, turn the thermostat to OFF immediately and let the solution cool for a few minutes before resuming the process.

 **WARNING**

Do not drain boil-out solution into a shortening disposal unit, a built-in filtration unit, or a portable filter unit. These units are not intended for this purpose, and will be damaged by the solution.

Pour cleaning solution into the frypot and add water to the top OIL LEVEL line scribed in the back of the frypot.

Set the operating thermostat dial to 225°F (107°C), just above that of boiling water.

- A. The main burner will ignite.
- B. When the solution nears the boiling point, reset the temperature controller to 200°(93°C).
- C. The burners should shut off just as the water starts to boil.

4.2 Boil-Out Procedure cont.

- D. The burners will heat the boil-out solution to a simmer. Simmer the solution for approximately 45 minutes. Wearing protective gloves, scrub the sides of the frypot and the tubes with the L-shaped Teflon brush, being careful not to disturb the temperature sensing probes and the high-limit thermostat.

SUPER MARATHON SERIES GAS FRYERS

CHAPTER 4: FRYER OPERATIONS

- E. Do not allow the water level to decrease below the top OIL LEVEL line in frypot during boil-out operation.

 **WARNING**

Water or boil-out solution MUST not be allowed to drain into the filter pan or filter system (where applicable). Irreversible damage will result if water is allowed into the system.

- F. After boil out is complete, turn the thermostat dial to "OFF" and drain the solution from the frypot. Place a metal stockpot of sufficient size to safely hold the entire contents of the frypot under the drain port to collect the water/boil-out solution.
- G. Filtration Equipped Units: Do not allow water or boil-out solution to drain into the filter pan. The filter pump is not designed for water operation, and will be irreparably damaged.
- H. Close the drain, add fresh water (without boil-out solution) and wash all surfaces of the frypot. Drain again.
- I. Refill the frypot with fresh water and vinegar to neutralize any residual boil-out solution. Wash all surfaces of the frypot. Drain completely and wipe down all surfaces of the frypot to completely remove all water.

 **DANGER**

Remove all drops of water from the frypot before filling with oil. Failure to do so will cause spattering of hot liquid when the oil is heated to cooking temperature and may cause injury to nearby personnel.

NOTE: It is recommended that the boil-out procedure be performed each time the oil is changed.

 **DANGER**

Do not go near the area directly over the flue outlet while the fryer is operating.

Always wear oil-proof, insulated gloves when working with the fryer filled with hot oil.

Always drain oil into a metal stockpot of sufficient size to safely hold the entire contents of the frypot.

SUPER MARATHON SERIES GAS FRYERS

CHAPTER 4: FRYER OPERATIONS

4.3 Final Preparation

 **WARNING**

NEVER set a complete block of solid shortening on top of heating tubes. To do so will damage the heating tubes and frypot, and void the warranty.

4.3.1 Filling the Fryer with Oil or Shortening

- A. When using liquid shortening or cooking oil, fill the fryer to the bottom OIL LEVEL line scribed into the back of the frypot.
- B. When using a solid shortening, cut it into small pieces and pack it below, between and above the heat tubes, leaving no air spaces around the tubes. Do not disturb or bend the sensing bulbs.
- C. After the shortening is packed around the tubes, turn the burners "ON" for about 10 seconds, "OFF" for a minute, etc., until the shortening is melted. If you see smoke coming from the shortening during the melting process, shorten the "ON" cycle and lengthen the "OFF" cycle. Smoke indicates potential scorching of the shortening, which will shorten its useful life.
- D. Before starting operation, turn the operating thermostat to the probable working temperature; wait for the temperature to stabilize then check with a high-quality immersion thermometer.

For filtration instructions and troubleshooting, consult the operating manual or instructions provided with the filtration equipment.

4.3.2 Extending Shortening/Oil Life

Although 350°F (177°C) is the recommended temperature for most cooking operations, set the fryer at the lowest possible temperature which produces a high quality product. This ensures maximum life of shortening.

When the fryer is not in use, set the thermostat to a lower temperature from that used during cooking. Light loads may be cooked at lower temperatures. Experiment to determine the optimum temperature and load conditions for various food items being cooked.

SUPER MARATHON SERIES GAS FRYERS

CHAPTER 5: PREVENTATIVE MAINTENANCE

5.1 General

 **DANGER**

Never attempt to clean the fryer during the cooking process or when the frypot is filled with hot oil. If water comes in contact with oil heated to cooking temperature, it will cause spattering of the oil, which can result in severe burns to nearby personnel.

Any equipment works better and lasts longer when maintained properly and kept clean. Cooking equipment is no exception. Super Marathon Series gas fryers should be kept clean during the working day and thoroughly cleaned at the end of each day. Below are recommendations for daily, weekly and periodic preventative maintenance.

5.1.1 Daily

 **WARNING**

Use a commercial grade cleaner formulated to effectively clean and sanitize food-contact surfaces. Read the directions for use and precautionary statements before use. Particular attention must be paid to the concentration of cleaner and the length of time the cleaner remains on the food-contact surfaces.

- A. Remove and wash all removable parts.
- B. Clean all exterior surfaces of the cabinet. Do not use cleaners, steel wool, or any other abrasive material on stainless steel.
- C. Filter the cooking oil and replace if necessary. The oil should be filtered more frequently when under heavy use.

5.1.2 Weekly

- A. Completely drain the oil from the fryer into a metal stockpot of sufficient size to safely hold the entire contents of the frypot for disposal. Do not use a glass or plastic container.
- B. Clean the frypot by following boil-out procedures in Chapter 4-2.

 **WARNING**

Never allow water to boil down and expose the heating tubes. Frypot damage will result.

SUPER MARATHON SERIES GAS FRYERS CHAPTER 5: PREVENTATIVE MAINTENANCE

5.1.3 Periodic/ Annual

The fryer should be inspected and adjusted periodically by qualified service personnel as part of a regular kitchen maintenance program.

Dean recommends that the fryer be inspected at least annually by a Factory Authorized Servicer as follows:

- Inspect fryer cabinet inside and out, front and rear, for excessive oil build-up and/or oil migration. Verify that burners and associated components (i.e. gas valves, pilot assemblies, piezo ignitors, etc.) are in good condition and functioning properly. Inspect all gas connections for leaks and ensure all connections are properly tightened.
- Verify that temperature and high-limit probes are properly connected, tightened and functioning properly.
- Verify that all electronic components (i.e. computer/controller, relays, transformers, interface boards, etc.) are in good condition and free from oil migration build-up and other debris. Inspect any wiring and ensure all connections are tight and all wiring is in good condition. Ensure all safety features (i.e. drain safety switches, reset switches, etc.) are present and functioning properly.
- Verify that frypot is in good condition and free of leaks. Verify that frypot tube diffusers are present and in good condition (i.e. no visible deterioration or damage).
- Verify that all wiring and connections are tight and in good condition.

See filtration manual for filtration maintenance procedures.

5.1.4 Stainless Steel Care

 **DANGER**

DO NOT let water splash into the tank of hot oil. Oil splatter will occur and can cause severe burns.

All stainless steel fryer cabinet parts should be wiped regularly with hot, soapy water during the day, and with a liquid cleanser designed for stainless steel at the end of each day.

- A. Do not use steel wool, abrasive cloths, cleansers or powders.
- B. Do not use a metal knife, spatula or any other metal tool to scrape stainless steel! Scratches are almost impossible to remove.
- C. If it is necessary to scrape the stainless steel to remove any encrusted materials, soak the area first to soften the deposit, then use a wood or nylon scraper only.

SUPER MARATHON SERIES GAS FRYERS

CHAPTER 6: TROUBLESHOOTING

6.1 General

 **DANGER**

Hot cooking oil will cause severe burns. Never attempt to move this appliance when filled with hot cooking oil or to transfer hot cooking oil from one container to another.

The problems and possible solutions covered are those most commonly encountered. To troubleshoot, perform the test set-up at the beginning of each condition. Follow each step in sequence.

6.2 Pilot Burner Malfunction

- A. Pilot will not ignite. No evidence of gas at pilot burner.
 - 1. Check that incoming service line gas valve is open and gas is present at the gas valve.
 - 2. Check pilot burner orifice for dirt or lint.
 - 3. Remove pilot burner gas-supply line and check for contamination; blow out if necessary, then reinstall.
- B. Pilot burner ignites but will not remain lit when gas valve manual knob is released (Non-CE), or the pilot button is released (CE).
 - 1. **For CE units:** Check that thermocouple lead is properly screwed into thermocouple connection bushing on gas valve.
 - 2. **For CE units:** Remove end of thermocouple lead from thermocouple connection bushing and clean with fine sandpaper or emery cloth.
 - 3. Check the thermopile leads where they connect to the gas valve making sure that the connection is clean and tight.
 - 4. Pilot flame may be too high or too low. Adjust pilot flame adjustment screw so that pilot flame extends about ¾-inch (22-mm) above the top of the pilot burner.
 - 5. Check all connections for cleanliness and security.
- C. Pilot flame of proper size, but is unstable. Flame wavers and does not envelope the thermocouple completely at all times.
 - 1. Check for drafts that might be caused by air conditioning equipment or make-up air apparatus. Turn air-moving equipment off and recheck the pilot.

SUPER MARATHON SERIES GAS FRYERS
CHAPTER 6: TROUBLESHOOTING

6.3 Main Burner Malfunctions

- A. Main burner will not come "ON"; gas not detected at main burner.
 - 1. Check that the gas valve is open.
 - 2. Check that the pilot is lit and is operating properly.
 - 3. Check the high-limit switch for continuity.
 - 4. The combination gas valve may be defective; replace if necessary.

- B. Main burner flames are small and appear lazy; shortening does not come up to temperature quickly.
 - 1. Check gas pressure at the pressure tap of the gas valve. Use dial type or standard water-type U-gauge manometer. With burner in operation, the pressure should match the pressures listed in the tables on page 3-10 – 3-11.
 - 2. If not, remove the pressure regulator adjustment cover. Use a screwdriver to turn the adjusting screw for proper pressure. Replace cover, re-check pressure and re-install pressure regulator adjustment cover.

- C. Signs of excessive temperature: shortening scorches and quickly becomes discolored.
 - 1. Check operating thermostat. May be out of adjustment or calibration. Recalibrate if necessary.
 - 2. Check gas pressure as outlined above.
 - 3. Shortening used is of inferior quality and/or shortening has been used too long. Replace shortening.
 - 4. Ensure frypot is clean when refilling with new shortening.

- D. Fryer will not reach the temperature setting and/or runs erratically.
 - 1. Incorrect location of sensor probe or defective temperature sensor.
 - 2. Loose wiring/wire connection.

- E. Fryer shortening temperature cannot be controlled; fryer runs at high-limit temperature.
 - 1. Defective operating thermostat. Call service technician.

SUPER MARATHON SERIES GAS FRYERS

CHAPTER 6: TROUBLESHOOTING

6.4 Wiring Diagrams

CE UNITS ONLY:

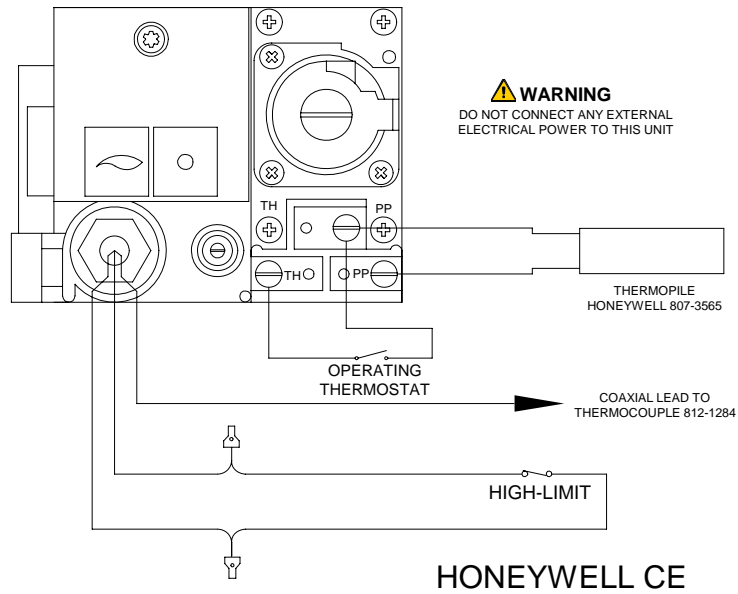

NON-CE UNITS ONLY:

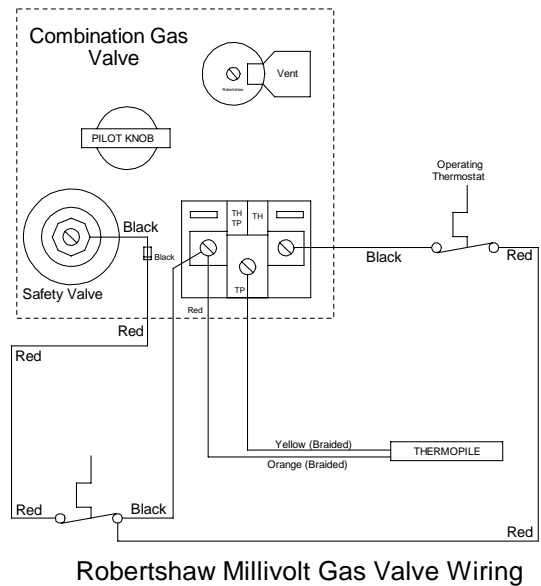
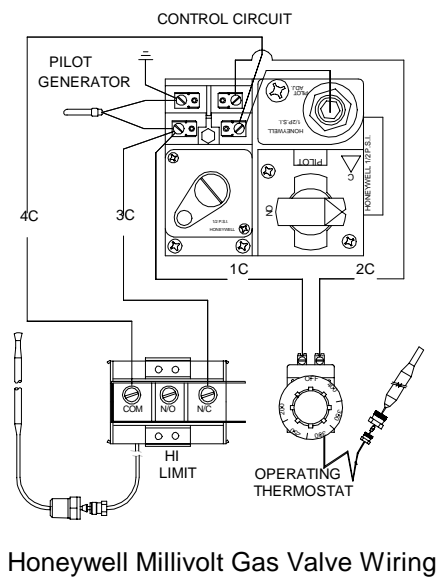

SUPER MARATHON SERIES GAS FRYERS
CHAPTER 6: TROUBLESHOOTING

6.5 Recommended Spare Parts

CE UNITS ONLY:

Commonly replaced parts in **CE** Super Marathon Series gas fryers are:

Gas Valve (Honeywell)- Natural- 807-2122
Gas Valve (Honeywell)- LP- 807-2121
High-Limit Thermostat- Manual Reset (CE- 210°C)- 807-3560
Thermopile- 807-3485
Thermocouple- 812-1284
Thermostat, Operating- 807-1692
Knob, Thermostat- 816-0139

NON-CE UNITS ONLY:

Commonly replaced parts in **Non-CE** Super Marathon Series gas fryers are:

Gas Valve (Honeywell)- Natural- 807-1603
Gas Valve (Honeywell)- LP- 807-1604
Gas Valve (Robertshaw)- Natural- 807-3645
Gas Valve (Robertshaw)- LP- 810-2399
High-limit Thermostat- 435°F Automatic Reset- 807-3516
High-limit Thermostat- 450°F Manual Reset- 807-3680
Thermopile- 810-2033
Thermostat, Operating- 826-2013
Knob, Thermostat- 810-2035

THIS PAGE INTENTIONALLY LEFT BLANK



Dean, 8700 Line Avenue, Shreveport, Louisiana 71106

TEL 1-318-865-1711

FAX (Parts) 1-318-688-2200

FAX (Tech Support) 1-318-219-7135

PRINTED IN THE UNITED STATES

SERVICE HOTLINE
1-800-551-8633

819-6001A
OCT 2011